



pipetman[®] **L**

Comfortable and Secure by Nature!



EN USER'S GUIDE

PIPETMAN L

SINGLE, MULTICHANNEL & FIXED MODELS

Contents	Page
1- INTRODUCTION	2
2- PARTS CHECK LIST	2
3- DESCRIPTION	3
4- SETTING THE VOLUME - Only for Single & Multichannel models	4
5- USER ADJUSTMENTS - Only for Fixed models	4
6- PIPETTING	5
7- GENERAL GUIDELINES FOR GOOD PIPETTING	7
8- ACCESSORIES	8
9- GLP FEATURES	8
10- TROUBLESHOOTING	8
11- LEAK TEST	9
12- MAINTENANCE	9
13- CLEANING AND DECONTAMINATION	11
14- SPECIFICATIONS	11
15- SPARE PARTS	14
EC DECLARATION OF CONFORMITY	15
WARRANTY	15



Decreased pipetting forces are due to the new designed piston assembly including the use of a very high quality of lubricant. The use of other lubricant **cancel**s the warranty of your pipette. This lubricant is available under the reference: 5440011070. Please contact your Gilson distributor.

1 - INTRODUCTION

PIPETMAN L is an air displacement pipette and is used with disposable tips. To answer the current needs of intensive use of pipettes, and still being conform to Gilson brand qualities, improvements have been implemented to our mechanical series:

- ▶ Light and comfortable body, both for right and left handed.
- ▶ All forces necessary to pipetting task dramatically decreased*.
- ▶ Lockable volume, except for the Fixed models.
- ▶ 2D code for traceability.
- ▶ Name tag.
- ▶ For the single variable volume models, you have the choice for an ejector plastic or a stainless steel ejector.

 * Implementation of new features to improve dramatically pipetting comfort has no impact on the legendary robustness, accuracy and precision of PIPETMAN.

Eight single channel models cover a volume range from 0.2 µL to 10 mL.

Fixed models cover a volume range from 1 µL to 5000 µL with 15 models.

Eight multichannel models cover a volume range from 0.5 µL to 300 µL.

2 - PARTS CHECK LIST

Just take a moment to verify that the following items are present:

Single models

- ▶ PIPETMAN L,
- ▶ User's Guide,
- ▶ Safety bag,
- ▶ Certificate of conformity (including bar-code sticker).

Multi channel models

- ▶ PIPETMAN L,
- ▶ User's Guide,
- ▶ Safety bag,
- ▶ Ejector spacer for D10 tips,
- ▶ Certificate of conformity (including bar-code sticker).

Fixed models

- ▶ PIPETMAN L Fixed,
- ▶ User's Guide,
- ▶ Safety bag,
- ▶ Adjustment key,
- ▶ Certificate of conformity (including bar-code sticker).

3 - DESCRIPTION



Please refer to the following chapters for a full description of the different parts and functions of the pipette.

Personal label

You can identify your pipette with a name tag:

- 1 Pry out the window by inserting a small screwdriver in the access slot.
- 2 Position the name tag in the slot.
- 3 Clip the window back into place.



4 - SETTING THE VOLUME - Only for Single and Multi-channel models

The volume of liquid to be aspirated is set using the volumeter. The dials are colored either black or red to indicate the position of the decimal point, depending on the model (see examples).

Lock System

Model	Color of volumeter numbers		
	Black	Red	Increment
P2L	µL	0.01 µL	0.002 µL
P10L to P20L - Lx10	µL	0.1 µL	0.02 µL
P100L - P200L - Lx200 - Lx300	µL	-	0.2 µL
P1000L	0.01 mL	mL	0.002 mL
P5000L	0.01 mL	mL	0.002 mL
P10mL	mL	0.1 mL	0.02 mL

For additional safety, the volume selected is lockable.

- With the left or right thumb, unlock the thumbwheel by pushing it up.
- The volume is set by turning the thumbwheel.
The thumbwheel may be turned using only one hand to slowly reach the required setting.
- Push down the thumbwheel; the new volume selected is locked.

To obtain maximum accuracy when setting the volume, proceed as follows:

- when **decreasing** the volume setting, slowly reach the required setting, making sure not to overshoot the mark.
- when **increasing** the volume setting, pass the required value by 1/3 of a turn and then slowly decrease to reach the volume, making sure not to overshoot the mark.

5 - USER ADJUSTMENTS - Only for Fixed models

PIPETMAN L Fixed is factory calibrated using distilled water and very high precision balances. The nominal value of the PIPETMAN L Fixed may be slightly adjusted to compensate for liquids of different density or viscosity.













To accommodate for density or viscosity, an adjustment with one full turn of the calibration key in either direction equals:

- ± 0.05 µL (models F1L to F2L)
- ± 0.2 µL (models F5L to F10L)
- ± 0.5 µL (models F20L to F25L)
- ± 2.0 µL (models F50L to F100L)
- ± 5.1 µL (models F200L to F250L)
- ± 20 µL (models F300L to F1000L)
- 102 µL (model F5000L).

 The cover is graduated in tenths of the key revolution (letters A, B, ... J) and is read from left to right. Each small graduation mark represents 0.25 of the distance between each letter.

To adjust the volume setting to compensate for a specific density or viscosity, engage the two hooks of the spanner tool inside the two small holes on the top of the body, then turn the key slowly:

- Clockwise** to decrease the volume ; making sure not to overshoot the mark.
- Counterclockwise** to increase the volume; pass the required value by 1/4 turn, then slowly decrease the volume to reach the required setting.

Multichannel models		Single models			
Lx10  7.5 µL	Lx20  12.5 µL	P2L  1.25 µL	P10L  7.5 µL	P20L  12.5 µL	P100L  75 µL
Lx200  125 µL	Lx300  125 µL	P200L  125 µL	P1000L  0.75 mL	P5000L  1.25 mL	P10mL  7.5 mL



 **Protection of your pipette and your work:**
If step 3 is forgotten, the volume selected will be automatically locked during the next purge.

 Adjustment of the factory calibration must only be performed using a special calibration key.



 Please hold the key in the highest position to avoid banging it into the hook.

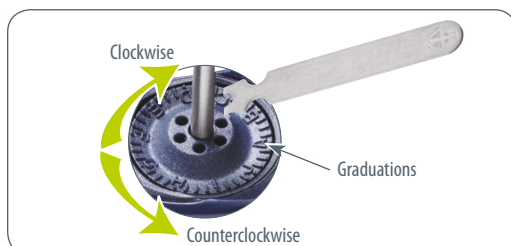

Example: When using a PIPETMAN L Fixed 100 to aspirate a particularly viscous solution, you may determine gravimetrically that the volume delivered is 98.8 μL , and the display reads "H". Therefore, you wish to increase the volume dispensed by 1.2 μL . As the interval between each letter on the calibration display represents 0.2 μL for the F100L (1/10 of 2 μL), the calibration tool must be turned 3 units until the display reads "B".

It is possible to alter the volume by more than one full turn in the counter-clockwise direction. In this case, remember to readjust the same number of turns when it is necessary to return to the original setting.

Check the new volume gravimetrically. If the volumes delivered are still not sufficiently close to the desired value, make another slight adjustment in the relevant direction. **Be sure to change tips between volume setting adjustments and to pre-rinse each new tip.**

When the PIPETMAN Fixed is readjusted to compensate for a particular solution, the nature of the liquid can be noted on the labels inserted in the slot under the counter.



Liquids of high density, vapor pressure, or viscosity are best pipetted by the MICROMAN positive displacement pipette.

6 - PIPETTING

For optimum performance, use of PIPETMAN DIAMOND Tips with your PIPETMAN L is strongly recommended. These tips, made from pure polypropylene have the Gilson logo engraved on their collar, ensuring that you have a **genuine** Gilson product. Plastic tips are for a single application – they must not be cleaned for reuse.

 PIPETMAN L can also be used with the main tip brands.

Fitting the tips - only for Single and Fixed models

To fit a new PIPETMAN DIAMOND Tip, push the tip-holder into the tip using a slight twisting motion to ensure a firm, airtight seal.

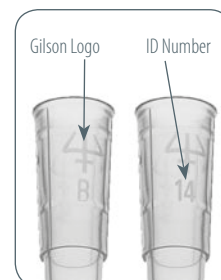

PIPETMAN DIAMOND Tip compatibility for Single models	
P2L, P10L	D10, DL10, DF10, DFL10
P20L	D200, DF30
P100L	D200, DF100
P200L	D200, DF200, D300, DF300
P1000L	D1000, D1200, DF1000, DF1200
PS5000L	D5000
P10mL	D10mL

PIPETMAN DIAMOND Tip compatibility for Fixed models	
F1L, F2L, F5L, F10L	D10, DL10, DF10, DFL10
F20L, F25L	D200, DF30
F50L, F100L	D200, DF100
F200L	D200, DF200
F250L	D300, DF300
F300L, F400L, F500L, F1000L	D1000, DF1000
F5000	D5000

For the P2L and P10L models equipped with stainless steel tip-ejector,

A dual-position adapter (plastic) is required to fit DL10 tips (long tips) or D10 tips (short tips).

P2L and P10L models are delivered with the adapter in place, ready to use DL10 tips. If D10 tips are used, the adapter must be repositioned in the shorter slot as follows:

- 1 Pull the adapter down from the metallic rod.
- 2 Turn the adapter through 180°.
- 3 Refit the adapter so that the end of the metallic rod engages the shorter slot of the adapter.

For the F1L, F2L, F5L, F10L, P2L and P10L models equipped with plastic tip-ejector,

A tip-ejector extension is supplied to fit with D10 tips (short tips).

To fit a tip-ejector extension:

- 1 Slide the extension over the tip-holder.
- 2 Push the extension firmly onto the end of the tip-ejector until it clicks into place.

To remove a tip-ejector extension:

- 1 Gently twist and pull the extension.
- 2 Pull it away from the pipette.

 Both dual-position adapter and tip-ejector extension are autoclavable.

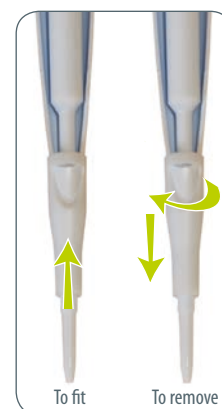

Fitting the tips - only for Multichannel models

 * Thanks to the new ejector spacer, you can adapt a D10 tip (see below).

PIPETMANDIAMOND Tip:TIPACK™ and TOWERPACK™ – ROCKY RACK™

PIPETMAN DIAMOND Tips are best fitted from the patented ROCKY RACK available only in our TIPACKS and TOWERPACKS.

ROCKY RACK is the dome-shaped part of the pack that contains the tips. ROCKY RACK makes it easy to securely fit the tips to a multichannel pipette, ensuring an airtight seal on all channels without the need to use undue pressure or to touch the tips.

PIPETMAN DIAMOND Tip compatibility for Multi channel models	
L8x10, L12x10	D10*, DL10, DF10, DFL10
L8x20, L12x20	DL10, DFL10, DF30, D200
L8x200, L12x200	D200, D300, DF200, DF300
L8x300, L12x300	D200, D300, DF200, DF300

The patented ROCKYRACK system available on TOWERPACK and TIPACK makes it extremely easy to fit tips on a multichannel pipette.



Ejector spacer for PIPETMAN L Multichannel 10 µL

According to the tip used, D10 or DL10, you might have to exchange the ejector spacer; the broad one is dedicated to D10, and the small one is dedicated to DL10:

- Remove the tip-ejector, keep both ejector locks depressed; pull the tip-ejector down.
- Gently press the tabs from the ejector spacer, and remove it from the tip-ejector.
- Insert the alternative ejector spacer and click it to the tip-ejector.
- To refit the tip-ejector, gently re-insert the tip-ejector vertically into the rails of the ejector support.

Pre-rinse the tips

Some liquids (e.g. protein-containing solutions and organic solvents) can leave a film of liquid on the inside wall of the tip; pre-rinse the tip to minimize any errors that may be related to this phenomenon.

Pre-rinsing consists of aspirating the first volume of liquid and then dispensing it to waste. Tips will not fall off nor will they have to be manually positioned.

Subsequent volumes that you pipette will have levels of accuracy and precision within specifications.

Aspirate

- 1 Press the push-button to the **first stop** (this corresponds to the set volume of liquid).
- 2 Hold the pipette vertically and immerse the tip in the liquid (see immersion depth table, page 7). Release the push-button slowly and smoothly (to top position) to aspirate the set volume of liquid. Wait one second (time depends on model, see table page 7); then withdraw the pipette-tip from the liquid. You may wipe any droplets away from the outside of the tip using a medical wipe, however if you do so take care to avoid touching the tip's orifice.

 For the Multichannel models, use a Gilson reagent reservoir.

Dispense

- 1 Place the end of the tip against the inside wall of the recipient vessel (at an angle of 10° to 40°).
- 2 Press the push-button slowly and smoothly to the **first stop**.
- 3 Wait for at least a second, then press the push-button to the **second stop** to expel any residual liquid from the tip.

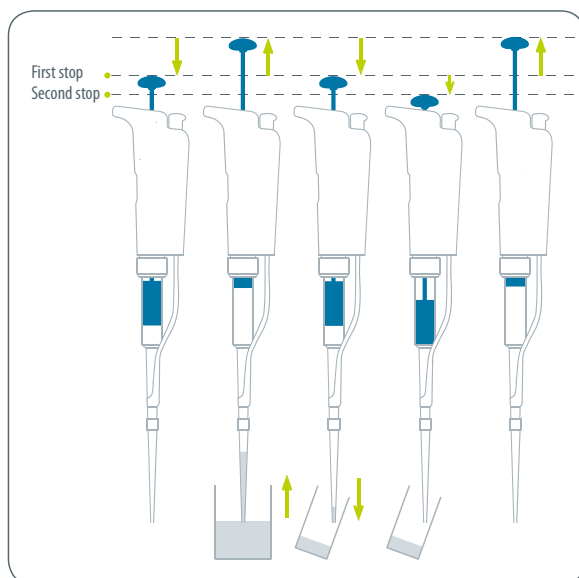
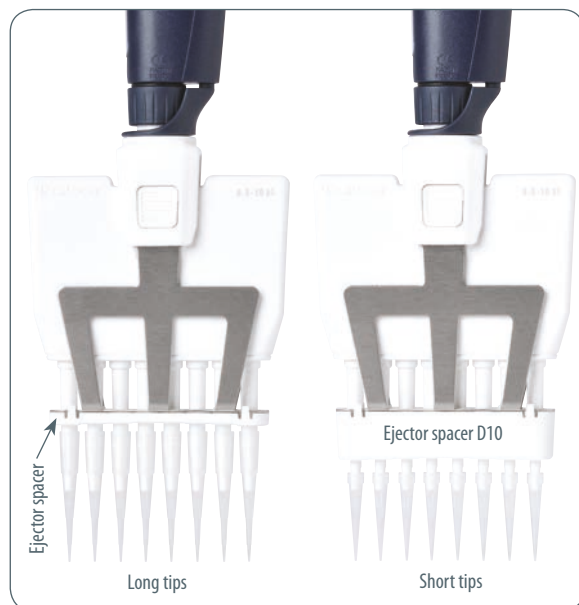

Keep the push-button pressed fully down and (while removing the pipette) draw the tip along the inside surface of the vessel.

- 4 Release the push-button, smoothly. Eject the tip by pressing firmly on the tip-ejector button.

 For the Multichannel models, use a Gilson reagent reservoir.

Ejecting the tip

Before you start to pipette, you can adjust the tip-ejector button according to your preferences.

- 1 Position the tip-ejector button. Simply rotate the tip-ejector button to the most comfortable position: left, right or middle.
- 2 Activate the tip-ejector. You can either push the tip-ejector button with the tip of the thumb as usual, or with the base of your thumb for more comfort. Please note the P5000L and P10mL are not equipped with a tip-ejector.



Single & Multichannel models



Fixed models



7 - GENERAL GUIDELINES FOR GOOD PIPETTING

- 1 Make sure that you operate the push-button slowly and smoothly.
- 2 When aspirating, keep the tip at a constant depth below the surface of the liquid (refer to the table).
- 3 Change the tip before aspirating a different liquid, sample, or reagent.
- 4 Change the tip if a droplet remains at the end of the tip from the previous pipetting operation.
- 5 Each new tip should be pre-rinsed with the liquid to be pipetted.
- 6 Liquid should **never** enter the tip-holder; to prevent this:
 - press and release the push-button slowly and smoothly,
 - never turn the pipette upside down,
 - never lay the pipette on its side when there is liquid in the tip.
- 7 If you use the same tip with a higher volume, pre-rinse the tip.
- 8 For volatile solvents you should saturate the air-cushion of your pipette by aspirating and dispensing the solvent repeatedly before aspirating the sample.
- 9 When the pipetted liquid is not at room temperature, pre-rinse the tip several times before use.
- 10 You may remove the tip-ejector (see Chapter 12 - Maintenance) to aspirate from very narrow tubes.
- 11 After pipetting acids or other corrosive liquids that emit vapors, remove the tip-ejector, the tip-holder, rinse, dry and lubricate the piston (see Chapter 12 - Maintenance). For the model P1000L, by using a specific tip holder equipped with a filter, you can increase the lifetime of the piston (see Chapter 8 - Accessories).
- 12 Do not pipette liquids having temperatures above 70 °C or below 4 °C. The pipette can be used between + 4 °C and + 40 °C but the specifications may vary according to the temperature (refer to the ISO 8655-2 standard for conditions of use).



The PIPETMAN L should be held in the vertical position.

Table - Immersion Depth and Wait Time

	Model	Immersion Depth (mm)	Wait Time (seconds)
Single	P2L	1	1
	P10L	1	1
	P20L	2-3	1
	P100L	2-4	1
	P200L	2-4	1
	P1000L	2-4	2-3
	P5000L	3-6	4-5
	P10mL	5-7	4-5
Multichannel	L8x10, L12x10	1	1
	L8x20, L12x20	2-3	1
	L8x200, L12x200	2-3	1
	L8x300, L12x300	2-4	1
Fixed	F1L, F2L, F5L, F10L	1	1
	F20L, F25L	2-3	1
	F50L, F100L, F200L, F250L	2-4	1
	F300L, F400L, F500L, F1000L	2-4	2-3
	F5000L	3-6	1

8 - ACCESSORIES

To make pipetting more comfortable and more secure, Gilson has developed several accessories:

- 1 To avoid the possibility of liquid running back into the pipette, store the pipette vertically.

 *Universal Multichannel Stand is for Multichannel only.*

- 2 To identify or personalize your pipette, COLORIS™ clips are available.

- 3 To protect the piston when pipetting corrosive liquids, you can use a specific tip holder and filter for the model P1000L.

CARROUSEL™ Pipette stand (7 pipettes)	F161401
TRIO™ stand (3 pipettes)	F161405
Universal Multichannel Stand	F161417
SINGLE™ pipette holder	F161406

COLORIS™ clips (mixed colors set of 10)	F161301
COLORIS™ clips (red, set of 10)	F161302
COLORIS™ clips (yellow, set of 10)	F161303
COLORIS™ clips (green, set of 10)	F161304
COLORIS™ clips (blue, set of 10)	F161305
COLORIS™ clips (white, set of 10)	F161306

Corrosion protection kit (tip holder + a bag of 10 filters)	F144570
---	---------

9 - GLP FEATURES

The **Serial Number** is engraved on the body of the pipette. It provides unique identification of your pipette and the date of manufacture. Example : **GB58672**

The **Bar Code** on the box and the certificate of conformity provide traceability of your pipette.

In addition a **2D code** is engraved next the Serial number: this code includes the ordering reference, the end date, the serial number and the nominal volume. Example: **FA10006 201103 GB58672 1000**

If you are equipped of a reader, you can integrate this information in your own traceability system.

Ordering reference: 7 characters - Blank - Manufacturing date (year and month): 6 characters - Blank - Serial number: 7 characters - Blank - Nominal volume in µL: up to 5 characters



10 - TROUBLESHOOTING

A quick inspection of the pipette may help you to detect a problem.

 *You may download from the Gilson website (www.gilson.com) the "2 minute inspection", which shows how to perform a quick diagnosis of your pipette.*

The following tables may help you to identify and correct the problem you might encounter.

For any other symptom or if you can't solve the problem, please contact your Gilson distributor.

 *Before returning any pipette to your local Gilson Service Center, ensure that it is completely free of chemical, biological, or radioactive contamination. Refer to Chapter 13 - Cleaning and Decontamination. Please use the included safety bag to return the pipette to your local Gilson Service Center.*

For Single and Fixed models

Symptom	Possible Cause	Action
Pipette is leaking sample	Damaged tip-holder Worn O-ring or seal	Replace the tip-holder Replace both parts and lubricate
Pipette won't aspirate	Worn O-ring Damaged tip-holder Connecting nut is loose Damaged or corroded piston Improper repair or assembly	Replace both parts and lubricate Replace the tip-holder Tighten connecting nut Return pipette to supplier See Chapter 12 - Maintenance
Pipette is inaccurate	Improper repair or assembly Unscrewed tip-holder Connecting nut is loose	See Chapter 12 - Maintenance Tighten connecting nut Tighten connecting nut
Pipette is not precise	Tip-holder is loose Connecting nut is loose Incorrect operator technique Damaged or corroded piston(s) Damaged tip-holder(s) Worn O-ring or seal	Tighten connecting nut Tighten connecting nut Operator training Return pipette to supplier Replace the tip-holder Replace both parts and lubricate
Tips fall off or do not fit correctly	Low quality tips Dirty tip-holder Damaged tip-holder(s) Damaged tip-ejector The tip-ejector is loose The ejector lock is misaligned	Use PIPETMAN DIAMOND tips Clean the tip-holder with isopropanol or ethanol Replace the tip-holder Replace tip-ejector Assemble the tip-ejector properly Align the ejector lock
Pipetting seize up	Piston need lubricant	Lubricate piston assembly

For Multichannel models

Symptom	Possible Cause	Action
Tips fall off or do not fit correctly	Low quality tips Tip-ejector damaged Ejector spacer damaged Dirty tip-holder Damaged tip-holder	Use PIPETMAN DIAMOND tips Replace tip-ejector Replace ejector spacer Clean them with ethanol or isopropanol Contact your local Gilson authorized service center
Pipette won't aspirate	Connecting nut is loose	Tighten connecting nut
Pipette is inaccurate	Connecting nut is loose	Tighten connecting nut
Pipette is not precise	Connecting nut is loose Incorrect operator technique	Tighten connecting nut Operator training

11 - LEAK TEST

This test may be performed at any time to check that the pipette does not leak, especially after performing a maintenance or decontamination procedure. If a pipette fails this test, replace the O-ring and seal. After making sure that the pipette is correctly reassembled, repeat this test.

For the P2L to P200L Single models, and the F1L to F250L Fixed models:

- 1 Fit a PIPETMAN DIAMOND Tip.
- 2 **For the variable volume**, set the pipette to the maximum volume given in the specifications, and pre-rinse.
- 3 Aspirate the set volume from a beaker of distilled water.
- 4 Maintain the pipette in the vertical position and wait for 20 seconds.
- 5 If a water droplet appears at the end of the tip there is a leak.
- 6 If you see no droplet, re-immers the tip below the surface of water.
- 7 The water level inside the tip should remain constant; if the level goes down there is a leak.

For the P1000L, P5000L and P10mL Single models, for the F300L to F5000L Fixed models:

- 1 Fit a PIPETMAN DIAMOND tip.
- 2 **For the variable volume**, set the pipette to the maximum volume given in the specifications.
- 3 Aspirate the set volume from a beaker of distilled water.
- 4 Maintain the pipette in the vertical position and wait for 20 seconds.
- 5 If a water droplet appears at the end of the tip, there is a leak.

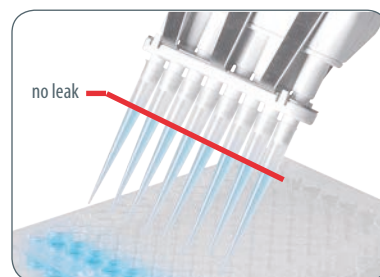

For the Multichannel models (8x-12x):

- 1 Fit the PIPETMAN DIAMOND tip.
- 2 Set the pipette to the maximum volume given in the specifications, and pre-rinse.
- 3 Aspirate the set volume from a reagent reservoir of distilled water.
- 4 Maintain the pipette in the vertical position and wait for 20 seconds ; fluid level in tips should remain constant.
- 5 If a water droplet appears at the end of the tip, there is a leak.
- 6 If you see no droplet, for volumes below 200 µL, re-immers the tip below the surface of water.
- 7 The water level inside the tip should remain constant; if the level goes down there is a leak.

12A - MAINTENANCE FOR THE SINGLE AND FIXED MODELS ONLY

Routine maintenance will help keep your pipette in good condition, ensuring a continued high level of performance.

Maintenance is limited to:

- ▶ Cleaning or decontamination (see Chapter 13 - Cleaning and Decontamination)
- ▶ Replacing spare parts
- ▶ Greasing the piston assembly.

PIPETMAN P2L and P10L, F1L, F2L, F5L and F10L should not be disassembled, so you may only replace the push-button, tip-ejector, dual position tip-ejector and its adapter. With these pipettes if the tip-holder is damaged, the piston may also be damaged.



After replacing any parts you **should** verify the performance of your pipette following the verification procedure available on the Gilson website (www.gilson.com). If the pipette needs to be readjusted, please contact your local Gilson authorized Service Center.

Changing the Tip-ejector

To remove

- 1 Push the ejection button.
- 2 Push laterally the tip-ejector.
- 3 Slide and remove the tip-ejector.

To refit

- 1 Push the ejection button.
- 2 Slide the tip-ejector along the tip-holder.
- 3 Clip the tip-ejector on the body of the pipette.

Changing the Tip-holder – no tools required

- 1 Remove the tip-ejector (see above).
- 2 Unscrew the connecting nut by turning it clockwise.
- 3 Carefully separate the lower and upper parts.
- 4 Remove the piston assembly and the seals.
- 5 Clean, autoclave, or replace the tip-holder.
- 6 If necessary, lubricate lightly the piston and its seals (see below).
- 7 Reassemble the pipette (refer to the figure, page 10).
- 8 Tighten the connecting nut (turn counterclockwise).
- 9 Refit the tip-ejector (see above).

Single models



Fixed models



Single models

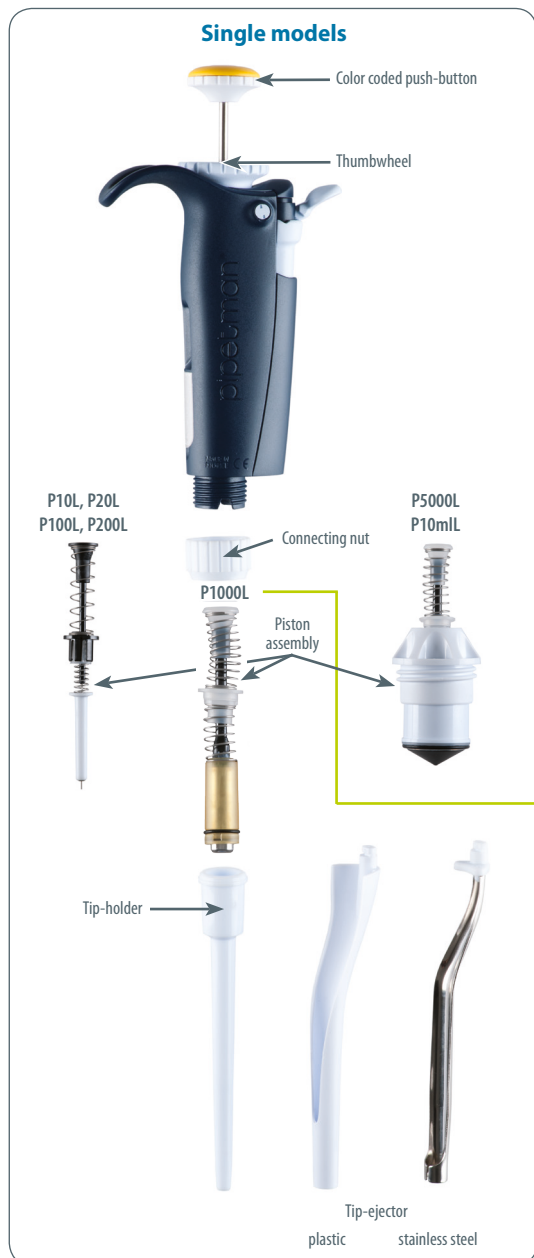

Fixed models

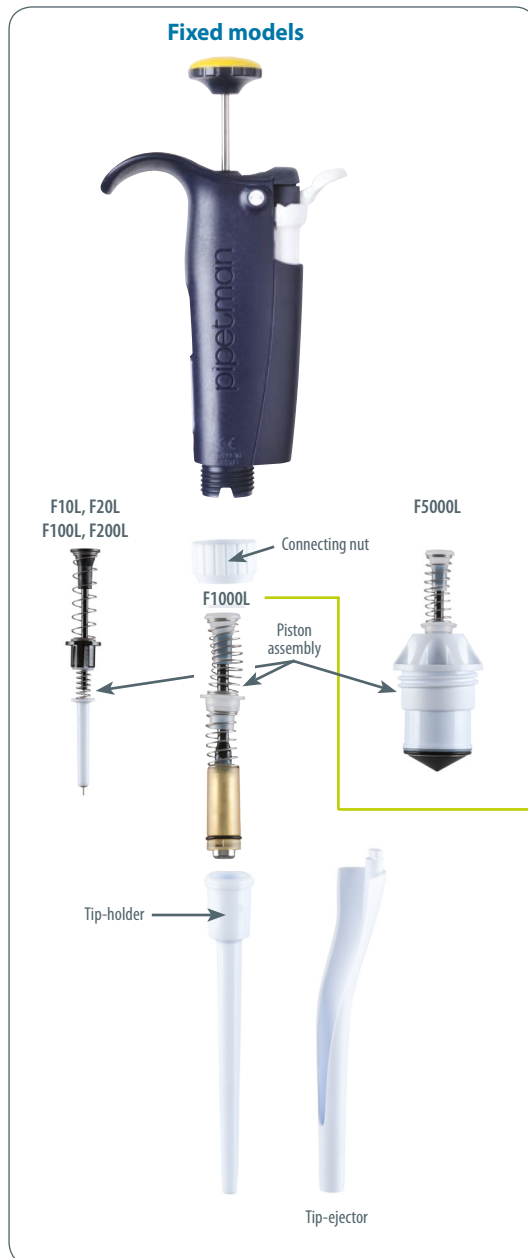

Servicing the Piston Assembly

You may remove the piston assembly for cleaning purposes only. If the piston assembly is changed, the pipette must be adjusted and calibrated in a Gilson authorized Service Center. As the models P2L and P10L, F1L, F2L, F5L and F10L contain miniaturized parts, it is best not to disassemble these pipettes yourself.



The piston assembly must not be autoclaved.

- 1 Remove the tip-ejector (see above).
- 2 Unscrew the connecting nut by turning it clockwise.
- 3 Carefully separate the lower and upper parts.
- 4 Remove the piston assembly, O-ring and seal.
- 5 Leave exposed the piston, clean it with isopropanol or ethanol and lubricate lightly.

For P20L, P100L, P200L, F20L, F25L, F50L, F100L, F200L, F250L: lubricate only the useful part of the piston (20 ±5 mm length) and the O-ring.

For P1000L, F300L, F400L, F500L and F1000L: lubricate the piston.

For P5000L, P10mL and F5000L: disassemble the seals, lubricate their internal part and lubricate the piston. Do not lubricate the O-ring.



The use of other lubricant cancels the warranty of this pipette.

- 6 Reassemble the pipette (refer to the figure, page 10).
- 7 Tighten the connecting nut (turn counter-clockwise).
- 8 Refit the tip-ejector (see above).

Changing the seals

The O-ring and seal are on the piston; **they must not be autoclaved**, if worn or damaged in any way (chemical or mechanical), they must be replaced. As the models P2L and P10L, F1L, F2L, F5L and F10L contain miniaturized parts, it is best not to disassemble these pipettes yourself, please contact your local Gilson authorized Service Center.

The dimensions of the O-ring vary depending on the model of pipette.

- 1 Remove the tip-ejector (see above).
- 2 Unscrew the connecting nut by turning it clockwise.
- 3 Carefully separate the lower and upper parts.
- 4 Remove the piston assembly, O-ring and seal.
- 5 If necessary clean the piston and replace the seal; lubricate them lightly. Please place them in the correct order.
- 6 Reassemble the pipette (refer to the figure, page 10).
- 7 Tighten the connecting nut (turn counter-clockwise).
- 8 Refit the tip-ejector (see above).

12B - MAINTENANCE FOR THE MULTICHANNEL MODELS ONLY

Routine maintenance will help keep your pipette in good condition, ensuring a continued high level of performance.

Maintenance is limited to:

- ▶ Cleaning or decontamination (see Chapter 13 - Cleaning and Decontamination)
- ▶ Replacing spare parts
- ▶ Greasing the piston assembly.

Changing the Tip-ejector

To remove the tip-ejector, keep both ejector locks depressed. Pull the tip-ejector down.

To refit the tip-ejector, gently re-insert the tip-ejector vertically into the rails of the ejector support. Pull lightly on the tip-ejector to check the position.

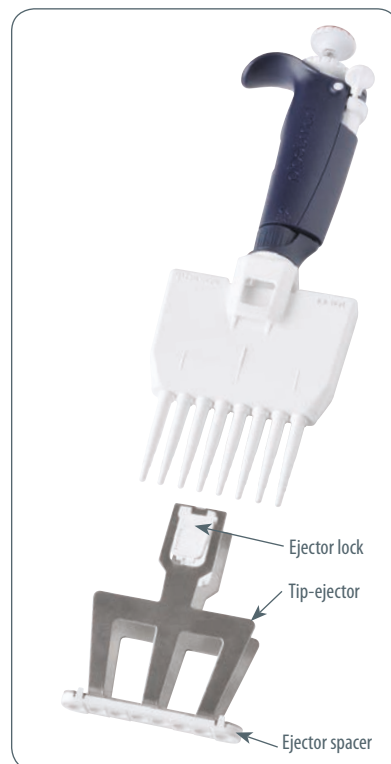
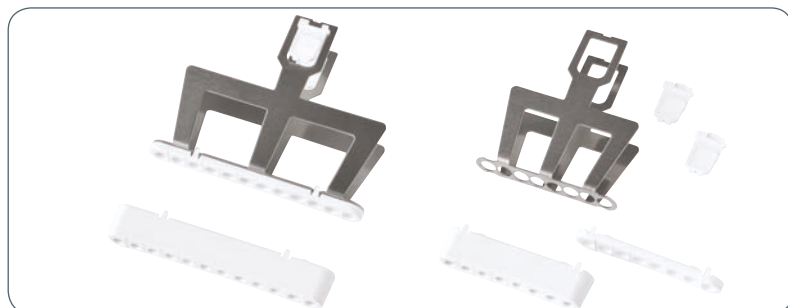

13 - CLEANING AND DECONTAMINATION

PIPETMAN L is designed so that the parts normally in contact with liquid contaminants, can easily be cleaned and decontaminated. However, because the models P2L and P10L, F1L, F2L, F5L and F10L contain miniaturized parts, it is best not to disassemble these pipettes yourself; please contact your local Gilson authorized Service Center.



You may refer to the decontamination procedure available on the Gilson website (www.gilson.com). Liquid must never enter the upper part (handle) of any pipette.

For the Single Models and Fixed Models only

The pipette must be cleaned, as described below, before it is decontaminated. Soap solution is recommended for cleaning PIPETMAN L.

Cleaning External

- 1 Remove the tip-ejector.
- 2 Wipe the tip-ejector with a soft-cloth or lint-free tissue impregnated with soap solution.
- 3 Wipe the entire pipette with a soft-cloth or lint-free tissue impregnated with soap solution, to remove all dirty marks. If the pipette is very dirty, a brush with soft plastic bristles may be used.
- 4 Wipe the entire pipette and the tip-ejector with a soft cloth or lint-free tissue soaked with distilled water.
- 5 Refit the tip-ejector and allow the pipette to dry.

Cleaning Internal

The following components **only** can be immersed in a cleaning solution: connecting nut, tip-ejector, tip-holder, piston assembly, seal and O-ring.

- 1 Disassemble the pipette as described in the Chapter 12A - Maintenance.
- 2 Set aside the upper part in a clean, dry place.
- 3 Clean the individual components of the lower part of the pipette using an ultrasonic bath (20 minutes at 50°C) or with a soft-cloth and brushes. Note that the piston assembly and seals must be degreased with isopropanol or ethanol before being immersed in another ultra sonic bath. Small round brushes with soft plastic bristles may be used to clean the interior of the tip-holder.
- 4 Rinse the individual components with distilled water.
- 5 Leave the parts to dry by evaporation or wipe them with a clean soft-cloth or lint-free tissue.
- 6 Reassemble the pipette as described in the Chapter 12A - Maintenance.

Autoclaving

The upper part (body) and the piston assembly of the pipette are **not** autoclavable. **Only** the following parts may be autoclaved: tip-ejector, tip-holder and connecting nut.

For the Multichannel Models only

The pipette must be cleaned, as described below, before it is decontaminated. Soap solution is recommended for cleaning PIPETMAN L.

Cleaning

The following components **only** can be immersed in a cleaning solution: tip-ejector, ejector locks and ejector spacer.

- 1 Remove the tip-ejector and the ejector spacer.
- 2 Immerse the tip-ejector, ejector locks and ejector spacer in the cleaning solution or wipe them with a soft cloth or lint-free tissue impregnated with the cleaning solution.
- 3 Rinse the components with distilled water.
- 4 Wipe the entire pipette with a soft cloth or lint-free tissue impregnated with the cleaning solution.
- 5 Wipe it with distilled water.
- 6 Leave the parts to dry by evaporation or wipe them with a clean soft-cloth or lint-free tissue.

The O-ring and seal are **not** autoclavable; they may be cleaned or replaced with the one specified in Chapter 15 - Spare Parts.

- 1 Clean the parts to be autoclaved, especially the tip-holder.
- 2 Put the parts in an autoclaving sack.
- 3 Autoclave for 20 minutes at 121°C, 0.1 MPa.
- 4 Check that the parts are dry before re-assembling the pipette.
- 5 Set the pipette aside to stabilize at room temperature.

Chemical Decontamination

You may choose to decontaminate your pipette chemically, in accordance with your own procedures. Whatever decontaminant you use, check with the supplier of the decontaminant that it is compatible with stainless steel and the plastics used in the construction of the pipette: PA (Polyamide), PBT (Polybutylene Terephthalate), PC (Polycarbonate), PC/PBT (Polycarbonate/Polybutylene Terephthalate), POM (Polyoxymethylene), PVDF (Polyvinylidene Fluoride), or PP (Polypropylene).

Upper Part (handle)

- 1 Wipe the upper part (handle) of the pipette with a soft-cloth or lint-free tissue impregnated with the chosen decontaminant.
- 2 Wipe the upper part of the pipette with a soft-cloth or lint-free tissue soaked with distilled water or sterile water.

Lower Part (Volumetric module)

The following components **only** can be immersed in a decontaminant solution: connecting nut, tip-ejector, tip-holder. Piston assembly and seals must be degreased with methyl alcohol before being immersed in decontamination solution in separate vessel.

- 1 Disassemble the pipette as described in the Chapter 12A.
- 2 Immerse tip-ejector, tip-holder and connecting nut in the cleaning solution.
- 3 Degrease the piston assembly, the seals and immerse them in another vessel.
- 4 Rinse each component with distilled water.
- 5 Leave the parts to dry by evaporation (or wipe with a soft cloth the tip-ejector, the tip-holder and connecting nut).
- 6 Lubricate the piston assembly and the seals.
- 7 Reassemble the piston assembly, the tip-holder and the tip-ejector.

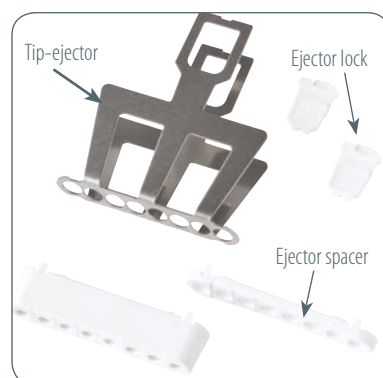

- 7 Refit the tip-ejector as described in "Changing the tip-ejector".

Please note that although the lower part of PIPETMAN L multichannel can withstand a few number of autoclaving cycles, we do not recommend autoclaving it.

Chemical Decontamination

You may choose to decontaminate your pipette chemically, in accordance with your own procedures. Whatever decontaminant you use, check with the supplier of the decontaminant that it is compatible with stainless steel and the plastics used in the construction of the pipette: PA (Polyamide), PBT (Polybutylene Terephthalate), PC (Polycarbonate), PC/PBT (Polycarbonate/Polybutylene Terephthalate), POM (Polyoxymethylene), PVDF (Polyvinylidene Fluoride), or PP (Polypropylene).

The following components **only** can be immersed in a decontamination solution: tip-ejector, ejector locks and ejector spacer.

- 1 Remove the tip-ejector and the ejector spacer.
- 2 Immerse the tip-ejector, ejector locks and ejector spacer in the decontamination solution or wipe them with a soft-cloth or lint-free tissue impregnated with the decontamination solution.
- 3 Rinse the components with distilled water.
- 4 Wipe the entire pipette with a soft cloth or lint-free tissue impregnated with the decontamination solution.
- 5 Wipe it with distilled water.
- 6 Leave the parts to dry by evaporation or wipe them with a clean soft-cloth or lint-free tissue.
- 7 Refit the tip-ejector as described in "Changing the tip-ejector".

14 - SPECIFICATIONS

PIPETMAN L is a high quality pipette that offers excellent accuracy and precision. The figures given in the "Gilson Maximum Permissible Errors" table were obtained using PIPETMAN DIAMOND Tips. These figures are guaranteed only when genuine PIPETMAN DIAMOND Tips are used.

Each pipette is inspected and validated by qualified technicians in accordance with the Gilson Quality System. Gilson declares that its manufactured pipettes comply with the requirements of the ISO 8655 standard, by type testing.

The adjustment is carried out under strictly defined and monitored conditions (ISO 8655-6).



The data given in the tables conform to the ISO 8655-2 Standard.

With a precise pipetting technique (see Chapter 7 - General guidelines for good pipetting) the P2L model may be used to aspirate volumes as low as 0.1 μL and the P10L model as low as 0.5 μL .

Gilson Maximum Permissible Errors

Single models

Single Model (Reference)	Volume (μL)	Maximum Permissible Errors			
		Gilson		ISO 8655	
		Systematic error (μL)	Random error (μL)	Systematic error (μL)	Random error (μL)
P2L (FA10001P) (FA10001M)	Min. 0.2	± 0.024	≤ 0.012	± 0.08	≤ 0.04
	0.5	± 0.025	≤ 0.012	± 0.08	≤ 0.04
	1	± 0.027	≤ 0.013	± 0.08	≤ 0.04
	Max. 2	± 0.030	≤ 0.014	± 0.08	≤ 0.04
P10L (FA10002P) (FA10002M)	Min. 1	± 0.025	≤ 0.012	± 0.12	≤ 0.08
	5	± 0.075	≤ 0.030	± 0.12	≤ 0.08
	10	± 0.100	≤ 0.040	± 0.12	≤ 0.08
P20L (FA10003P) (FA10003M)	Min. 2	± 0.10	≤ 0.03	± 0.20	≤ 0.10
	10	± 0.10	≤ 0.05	± 0.20	≤ 0.10
	Max. 20	± 0.20	≤ 0.06	± 0.20	≤ 0.10
P100L (FA10004P) (FA10004M)	Min. 10	± 0.35	≤ 0.10	± 0.80	≤ 0.30
	50	± 0.40	≤ 0.12	± 0.80	≤ 0.30
	Max. 100	± 0.80	≤ 0.15	± 0.80	≤ 0.30
P200L (FA10005P) (FA10005M)	Min. 20	± 0.50	≤ 0.20	± 1.60	≤ 0.60
	100	± 0.80	≤ 0.25	± 1.60	≤ 0.60
	Max. 200	± 1.60	≤ 0.30	± 1.60	≤ 0.60
P1000L (FA10006P) (FA10006M)	Min. 100	± 3	≤ 0.6	± 8	≤ 3.0
	500	± 4	≤ 1.0	± 8	≤ 3.0
	Max. 1000	± 8	≤ 1.5	± 8	≤ 3.0
P5000L (FA10007)	Min. 500	± 12	≤ 3	± 40	≤ 15
	2500	± 15	≤ 5	± 40	≤ 15
	Max. 5000	± 30	≤ 8	± 40	≤ 15
P10mL (FA10008)	Min. 1000	± 30	≤ 6	± 60	≤ 30
	5000	± 40	≤ 10	± 60	≤ 30
	Max. 10000	± 60	≤ 16	± 60	≤ 30

Multichannel models

Multichannel Model (Reference)	Volume (μL)	Maximum Permissible Errors			
		Gilson		ISO 8655	
		Systematic error (μL)	Random error (μL)	Systematic error (μL)	Random error (μL)
L8x10 (FA10013)*	Min. 0.5	± 0.08	≤ 0.04	± 0.24	≤ 0.16
	1	± 0.08	≤ 0.05	± 0.24	≤ 0.16
	5	± 0.2	≤ 0.1	± 0.24	≤ 0.16
L12x10 (FA10014)*	Min. 10	± 0.2	≤ 0.1	± 0.24	≤ 0.16
	20	± 0.4	≤ 0.15	± 0.40	≤ 0.20
	100	± 1.0	≤ 0.40	± 3.2	≤ 1.2
L8x200 (FA10009)*	Min. 2	± 0.10	≤ 0.08	± 0.40	≤ 0.20
	10	± 0.2	≤ 0.10	± 0.40	≤ 0.20
	Max. 20	± 0.4	≤ 0.15	± 0.40	≤ 0.20
L12x200 (FA10010)*	Min. 20	± 0.50	≤ 0.25	± 3.2	≤ 1.2
	100	± 1.0	≤ 0.40	± 3.2	≤ 1.2
	Max. 200	± 2.0	≤ 0.5	± 3.2	≤ 1.2
L8x300 (FA10015)	Min. 20	± 1	≤ 0.35	± 8	≤ 3
	30	± 1	≤ 0.35	± 8	≤ 3
	Max. 300	± 3	≤ 1	± 8	≤ 3
L12x300 (FA10016)	Min. 150	± 1.5	≤ 0.6	± 8	≤ 3
	300	± 3	≤ 1	± 8	≤ 3

Fixed models

Fixed Model (Reference)	Volume (μL)	Maximum Permissible Errors			
		Gilson		ISO 8655	
		Systematic error (μL)	Random error (μL)	Systematic error (μL)	Random error (μL)
F1L (FA10017)	1	± 0.020	≤ 0.015	± 0.05	≤ 0.05
F2L (FA10018)	2	± 0.050	≤ 0.020	± 0.08	≤ 0.04
F5L (FA10019)	5	± 0.05	≤ 0.025	± 0.125	≤ 0.075
F10L (FA10020)	10	± 0.060	≤ 0.030	± 0.12	≤ 0.08
F20L (FA10021)	20	± 0.100	≤ 0.050	± 0.2	≤ 0.1
F25L (FA10022)	25	± 0.200	≤ 0.070	± 0.5	≤ 0.2
F50L (FA10023)	50	± 0.35	≤ 0.12	± 0.5	≤ 0.2
F100L (FA10024)	100	± 0.55	≤ 0.15	± 0.8	≤ 0.3
F200L (FA10025)	200	± 1.20	≤ 0.30	± 1.6	≤ 0.6
F250L (FA10026)	250	± 1.50	≤ 0.75	± 4	≤ 1.5
F300L (FA10027)	300	± 2.4	≤ 0.5	± 4	≤ 1.5
F400L (FA10028)	400	± 2.4	≤ 0.8	± 4	≤ 1.5
F500L (FA10029)	500	± 3.0	≤ 0.8	± 4	≤ 1.5
F1000L (FA10030)	1000	± 5.0	≤ 1.3	± 8	≤ 3
F5000L (FA10031)	5000	± 20.0	≤ 7.0	± 40	≤ 15



Each Single pipette model (except P5000L and P10mL) has two different ordering references to identify the kind of tip-ejector required. For a pipette with a plastic tip-ejector, the ordering reference is ended by the letter P, for a pipette with a stainless steel tip-ejector, the ordering reference is ended by the letter M.

Ex: For a P10L model with the plastic tip-ejector the ordering reference is FA10002P. For the same pipette with a stainless steel tip-ejector, the ordering reference is FA10002M.

15A - SPARE PARTS FOR SINGLE MODELS

Service Kit 1st level

includes:

- 3 piston seals or seal guides **C**
- 3 O-rings **D**
- 1 tip-holder **E**

Service Kit 2nd level

includes:

- 1 push-button **A**
- 1 connecting nut **B**
- 2 tip-ejectors **F1** **F2**

for the P2L and P10L models only:

- 1 adapter for stainless steel tip-ejector **F3**
- 1 extension for plastic tip-ejector **F4**

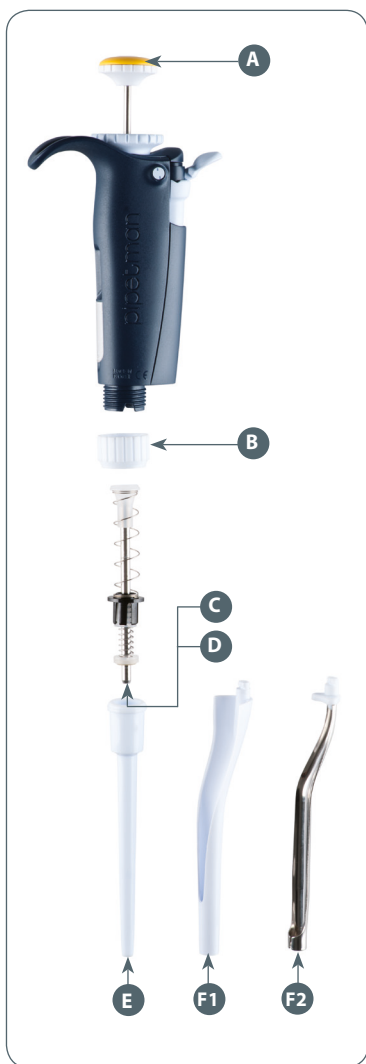

P2L (FA10001 P or M) and P10L (FA10002 P or M)

Description	P2L	P10L	
C+D+E	Service Kit 1st level	F144501	FA07001
A+B+F1 to F4	Service Kit 2nd level	FA07006	FA07007
C+D	Seal + O-ring (5 sets)	F144861	FA07012
F3	Tip-ejector adapter	F144879	F144879
F4	Tip-ejector extension	F2070903	F2070903

P20L (FA10003 P or M) and P100L (FA10004 P or M)

Description	P20L	P100L	
C+D+E	Service Kit 1st level	FA07002	FA07003
A+B+F	Service Kit 2nd level	FA07008	FA07009
C+D	Seal guide + O-ring (5 sets)	FA07013	FA07014

P200L (FA10005 P or M) and P1000L (FA10006 P or M)

Description	P200L	P1000L	
C+D+E	Service Kit 1st level	FA07004	FA07005
A+B+F	Service Kit 2nd level	FA07010	FA07011
C+D	Seal guide + O-ring (5 sets)	FA07015	FA07016

P5000L (FA10007) and P10mL (FA10008)

Description	P5000L	P10mL	
C+D+E	Service Kit 1st level	FA07021	FA07022
A	Push-button assembly	FA07019	FA07020
C+D	Seal + O-ring (5 sets)	FA07017	FA07018
E	Tip-holder	F123608	F161263

Each Single pipette model (except P5000L and P10mL) has two different ordering references to identify the kind of tip-ejector required. For a pipette with a plastic tip-ejector, the ordering reference is ended by the letter P, for a pipette with a stainless steel tip-ejector, the ordering reference is ended by the letter M.

Ex: For a P10L model with the plastic tip-ejector the ordering reference is FA10002P. For the same pipette with a stainless steel tip-ejector, the ordering reference is FA10002M.

ALL MODELS

Description	Ordering reference
Lubricant	5440011070

15B - SPARE PARTS FOR MULTICHANNEL MODELS

L8x10 (FA10013) and L12x10 (FA10014)

Description	8x10	12x10	
F3 - F4	Tip-ejector	F507005	F507006
G	Ejector lock	F507008	F507008
H1 - H2	Ejector spacer	F507001	F507003
H3 - H4	Ejector spacer D10	F807114	F807115

L8x20 (FA10009) and L12x20 (FA10010)

Description	8x20	12x20	
F3 - F4	Tip-ejector	F507005	F507006
G	Ejector lock	F507008	F507008
H1 - H2	Ejector spacer	F507001	F507003
H3 - H4	Ejector spacer D10	F807114	F807115

L8x200 (FA10011) and L12x200 (FA10012)

Description	8x20	12x20	
F3 - F4	Tip-ejector	F507005	F507006
G	Ejector lock	F507008	F507008
H1 - H2	Ejector spacer	F507001	F507003

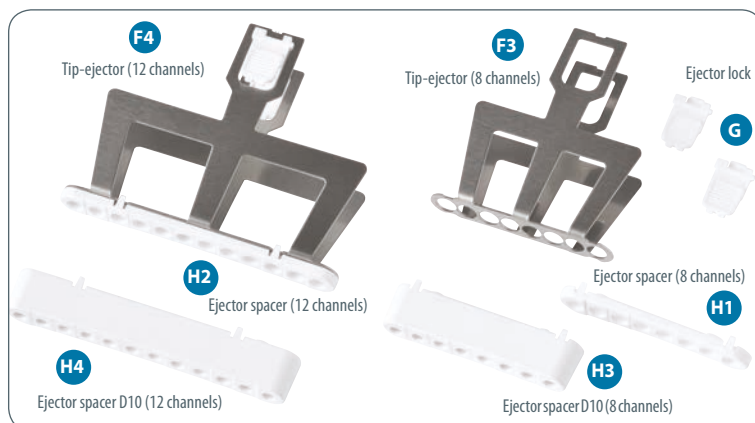

L8x300 (FA10015) and L12x300 (FA10016)

Description	8x20	12x20	
F3 - F4	Tip-ejector	F507005	F507006
G	Ejector lock	F507008	F507008
H1 - H2	Ejector spacer	F507001	F507003

15C - SPARE PARTS FOR FIXED MODELS

Service Kit 1st level

includes:

- 3 piston seals or seal guides **C**
- 3 O-rings **D**
- 1 tip-holder **E**

Service Kit 2nd level

includes:

- 1 push-button **A**
- 1 connecting nut **B**
- 1 tip-ejector **F1**

for the **F1L, F2L, F5L** and **F10L** models only:

- 1 extension for plastic tip-ejector **F4**

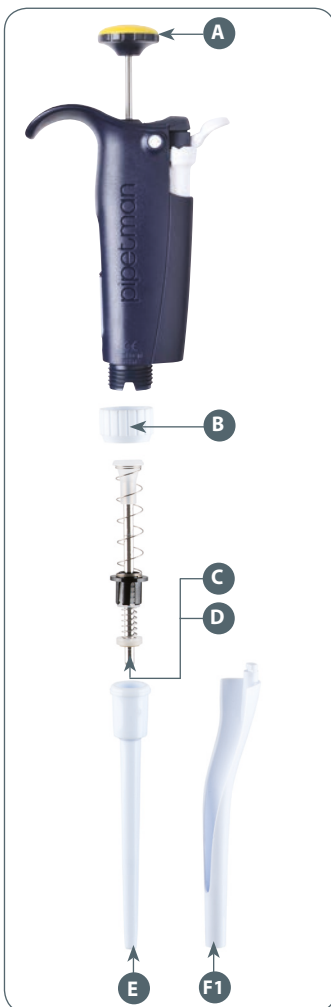

F1L (FA10017), F2L (FA10018), F5L (FA10019), F10L (FA10020)

Description	F1L/F2L	F5L/F10L	
C+D+E	Service Kit 1st level	F144501	FA07001
A+B+F1	Service Kit 2nd level	FA07067	FA07068
C+D	Seal + O-ring (5 sets)	F144861	FA07012
F4	Tip-ejector extension	F2070903	F2070903

F20L (FA10021), F25L (FA10022), F50L (FA10023) and F100L (FA10023),

Description	F20L/F25L	F50L/F100L	
C+D+E	Service Kit 1st level	FA07002	FA07003
A+B+F1	Service Kit 2nd level	FA07069	FA07070
C+D	Seal guide + O-ring (5 sets)	FA07013	FA07014

F200L (FA10025), F250L (FA10026),

Description	F200L	F250L	
C+D+E	Service Kit 1st level	FA07004	FA07004
A+B+F1	Service Kit 2nd level	FA07071	FA07073
C+D	Seal guide + O-ring (5 sets)	FA07015	FA07015

F300L (FA10027), F400L (FA10028), F500L (FA10029) and F1000L (FA10030) F5000L (FA10031)

Description	F300L/F400L F500L/F1000L	F5000L	
C+D+E	Service Kit 1st level	FA07005	FA07021
A+B+F1	Service Kit 2nd level	FA07072	NA
C+D	Seal + O-ring (5 sets)	FA07016	FA07017

ALL MODELS

Description	Ordering reference
Lubricant	5440011070

WARRANTY

Gilson warrants this pipette against defects in material under normal use and service for a period of 12 months from the date of purchase.

This warranty shall not apply to pipettes which are subject to abnormal use and/or improper or inadequate maintenance (contrary to the recommendations given in the User's guide), including, but not limited to pipettes which have been subjected to physical damage, improper handling, or spillage or exposure to any corrosive environment. This warranty shall also be void in the event pipettes are altered or modified by any party other than Gilson or its designates. Gilson's sole liability under this warranty shall be limited to, at Gilson's sole option, repair or replacement of any defective components of pipettes or refund of the purchase price paid for such pipettes.

THE FOREGOING WARRANTY IS EXCLUSIVE AND GILSON HEREBY DISCLAIMS ALL OTHER WARRANTIES, WHETHER EXPRESS OR IMPLIED, INCLUDING ANY WARRANTIES OF MERCHANTABILITY AND ANY WARRANTIES OF FITNESS FOR A PARTICULAR PURPOSE, UNDER NO CIRCUMSTANCES SHALL GILSON BE LIABLE FOR ANY CONSEQUENTIAL, PUNITIVE, INDIRECT OR INCIDENTAL DAMAGES ARISING OUT OF ANY BREACH OF ANY EXPRESS OR IMPLIED WARRANTY.

EC DECLARATION OF CONFORMITY

The company,

GILSON S.A.S.

19, avenue des Entrepreneurs
BP. 145 - 95400 Villiers-le-Bel (France)
Tel.: +33(0) 1 34 29 50 00
Fax: +33(0) 1 34 29 50 20
www.gilson.com

Hereby certifies on its sole responsibility that the products listed below:

PIPETMAN® L

P2L, P10L, P20L, P100L, P200L, P1000L, P5000L and P10mL

L8x10, L12x10, L8x20, L12x20,

L8x200, L12x200, L8x300, L12x300

F1L, F2L, F5L, F10L, F20L, F25L, F50L, F100L, F200L, F250L, F300L, F400L, F500L, F1000L, F5000L

comply with the requirements of the following European Directives:

98/79/EC* on In Vitro Diagnostic Medical Devices

* Annex III, self-declared

Villiers-le-Bel, January 14th, 2013

A. El Sayed
General Manager

H. Ledorze
Quality Manager



LT801124/D - ©2013 Gilson SAS All rights reserved January 2013
English Printed in France
Specifications subject to change without notifications - errors omitted.

www.gilson.com

sales@gilson.com
service@gilson.com
training@gilson.com



Gilson, Inc. World Headquarters

3000 Parmenter Street | P.O. Box 620027 | Middleton, WI 53562-0027, USA
Tel: (1) 800-445-7661 or (1) 608-836-1551 | Fax: (1) 608-831-4451

Gilson S.A.S.

19, avenue des Entrepreneurs | BP 145, F-95400 Villiers-le-Bel, France
Tel: +33 (0) 1 34 29 50 00 | Fax: +33 (0) 1 34 29 50 20