

OLYMPUS[®]

Your Vision, Our Future

Digital Cameras for Microscopy

Camera Overview

For Materials Science Microscopes

NEW

Olympus Digital Cameras for Materials Science Applications: For Clear and Precise Image Analysis



Passionate about Imaging

Olympus Digital Cameras — Trusted Performance

Versatility, performance, color reproduction and integration into Olympus imaging platforms are among the characteristics of all Olympus cameras. Today's digital cameras are an indispensable tool in microscopy systems. The need to reliably acquire clear crisp images is vital to every microscopist. No one understands this better than Olympus with its long and successful history in microscopy and lens design. Based on exceptional knowledge in opto-digital technology, Olympus has developed a comprehensive range of digital cameras that covers the vast array of applications in materials science.

Image Sensor for ultimate resolution

The camera sensor is the heart of any digital camera. This electronic component is responsible for digitizing images, acquiring, storing and converting electron signals within an array. Sensors have a variety of resolutions measured by the number of pixels in their array. Depending on the camera type, the sensor used contain various number of pixels, different pixel size and mechanisms that convert light into electrons resulting in subtle changes in brightness — thereby defining the ultimate resolution of the digital image.

Two main sensor types

Olympus utilizes only highly efficient and quality CCD and CMOS sensors for its camera range. CMOS sensors as used in the SC30 and SC100 are very energy efficient and perfect for acquiring images in high light level conditions such as brightfield. Often used for general inspection purposes, this sensor is cost efficient and fast. For research applications, the sensor of choice is the CCD. This scientific grade sensor, having all pixels devoted to light capture and near dark uniformity, offers the most flexibility in performance specifications. This sensor type is used in most of the Olympus cameras for microscopy.

Pixel shift technology

Having nine times the details of stationary sensors cameras, this technology is ideal for optimizing the resolution on your microscope, and essential feature for low power microscopes. In addition, a new 3-CCD pixel shift mode in DP73 enables three-color image resolution (RGB) within a single pixel to improve resolution even more.

Efficiency and speed

Sensor signal processing is a crucial aspect to deliver breakthrough camera technology and reliable performance in the diverse range of industrial applications. Olympus cameras can detect up to 14 bits per channel, a promise to perform quickly and efficiently threshold based image analysis with confidence. High frame rates guarantee real-time image viewing to focus and navigate areas of interest directly on the PC screen.

Color fidelity

Ensuring accurate reproduction and recording of colors is of utmost importance and a major challenge in image processing and documentation. Olympus cameras incorporate sophisticated algorithms in support of distinguishable color intensities assuring maximum dynamic range and color fidelity.

Sensitivity

Cameras with sensitive sensors are normally useful for difficult imaging conditions and for image analysis applications. Sensitivity of Olympus cameras can be increased by using various binning modes.

Software control

The complete integration of all Olympus cameras in OLYMPUS Stream provide intuitive operation from basic or advanced image acquisition to image processing, report generation, data export and global networking of image and reports.

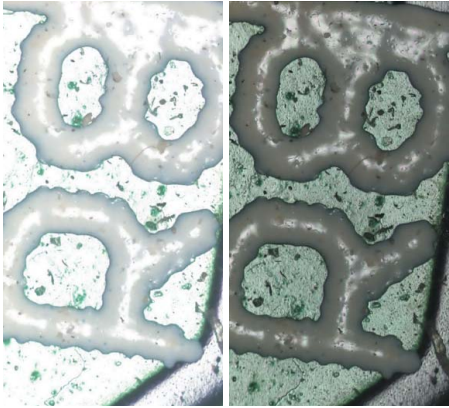
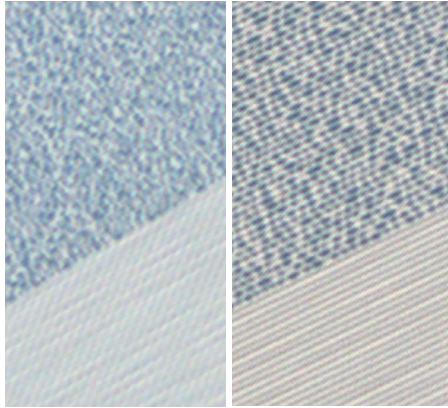
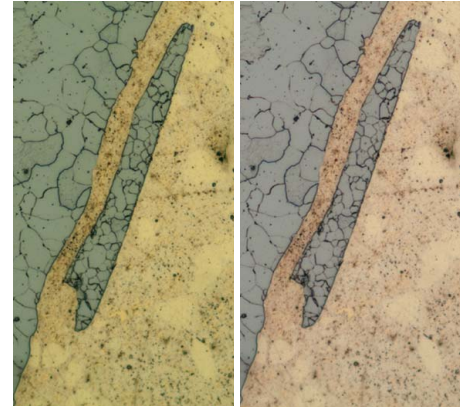

Image improvement—
Left: Without HDR, Right: With HDR



Improved resolution—
Left: Standard camera, Right: High resolution camera



Improved color reproduction—
Left: Without color correction, Right: With color correction

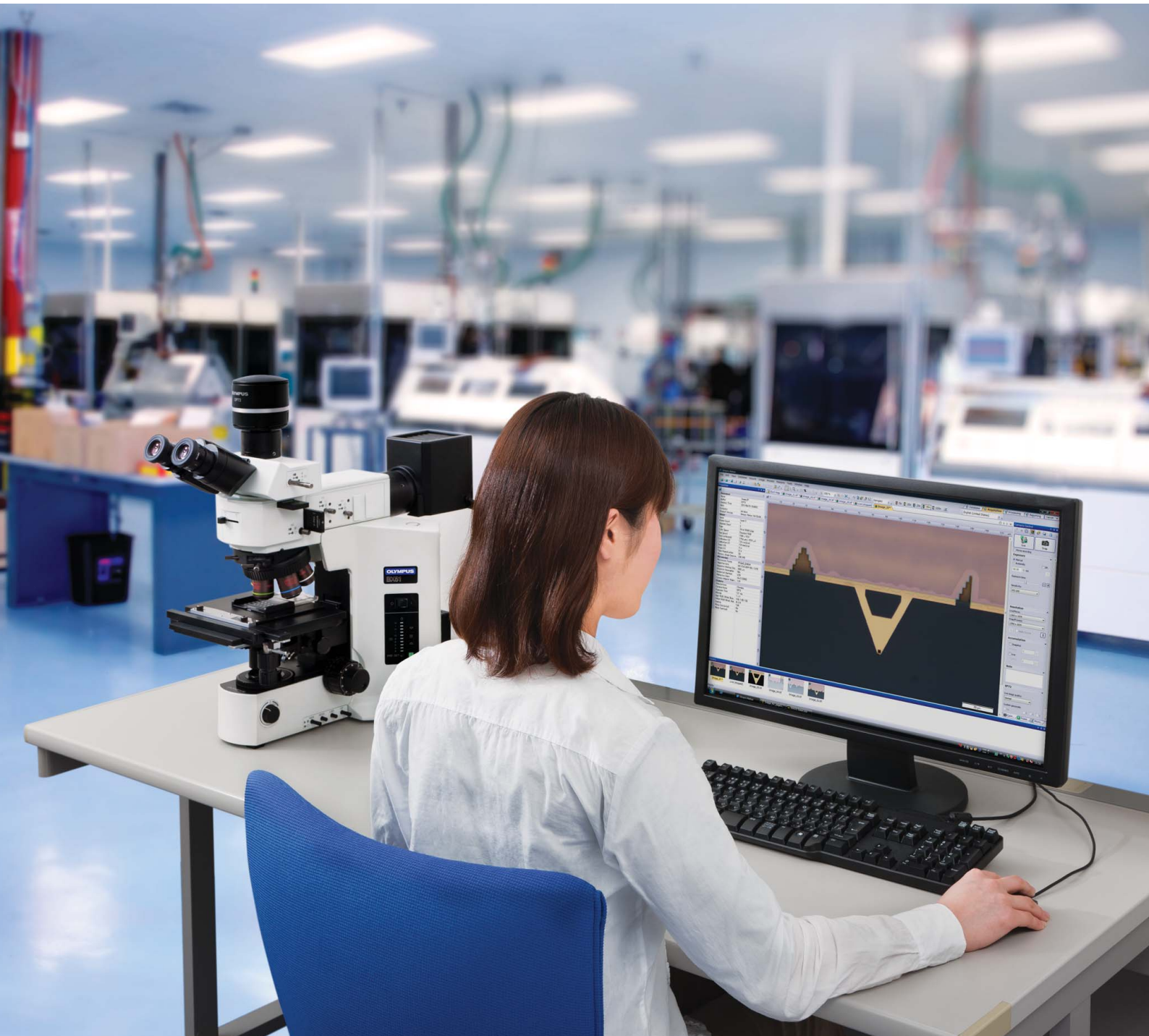

Perfect Fit for Every Application

Olympus' Broad Range of Digital Camera

Modern microscopy challenges require an extensive range of sensors. Olympus offers a sophisticated portfolio of digital color and monochrome cameras that cover all material science applications for today and tomorrow. The sensor line-up ranges from cameras for documentation purposes to cooled, high-performance, high-sensitivity cameras for advanced applications. All cameras are confirmed their best digital imaging performance with Olympus Microscopes and Imaging Analysis Software systems.

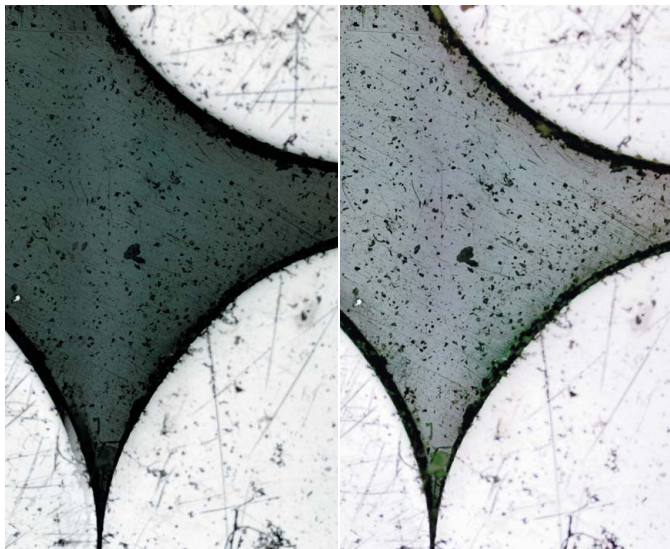

DP73 — Image acquisition using standard mode (left) and WiDER (right)

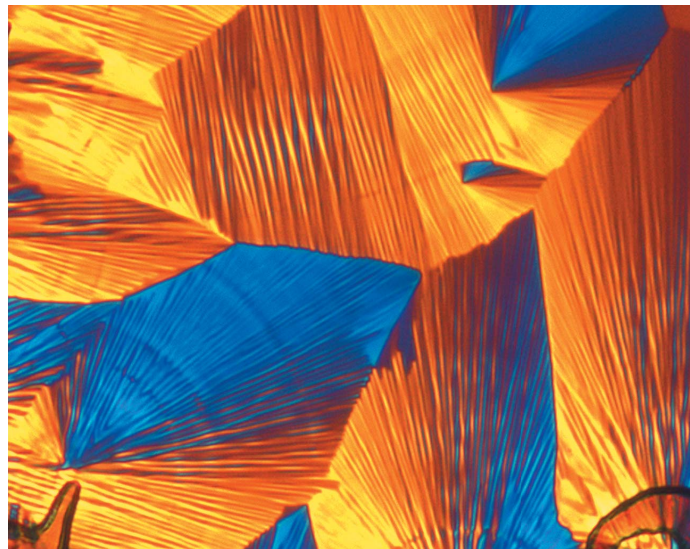

Outstanding performance — Polarization image acquired with the XC10

Universal Models

Universal cameras have it all: high resolution, high sensitivity and high-speed data transfer in any illumination mode. This makes them suitable for any applications in inspection, quality control and materials science research, e.g. image analysis or digital bright field documentation. These cameras provide outstanding operational ease with its real-time image viewing, color fidelity for the highest performance and special modes for image acquisition in difficult lighting conditions — like the unique WiDER mode (DP73), an application that optimizes contrast and brightness in individual image regions.

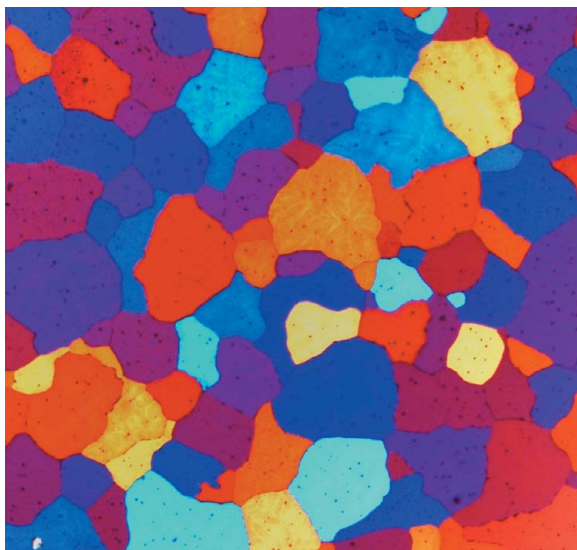

Etched aluminum acquired with DP27

Stream Report

Image Name: D0811-0117
Creation Time: 25.09.2009 16:54:31
Size: 355,2 µm x 281,4 µm
Comment: Estimation of phase fractions

14.04.2011 Page 1 of 1

Perfect suited for digital documentation

Stream Report

Project No:	Project 10	Date:	04.02.2011
Sample No.:	al 209	Operator:	Ala
Sample:	vstovec 2	Gain/mv (mg):	1.2

14.04.2011 Page 1 of 1

Standard Model

It is always preferable to have a choice when it comes to matching your digital imaging requirements and your budget. Balancing price and performance, the range of Olympus standard cameras gives you the ability to select between CCD or CMOS models, sensors with resolution up to 10.6 Megapixel, fast frame rates up to 45 fps, or cooling option. Whatever model you finally choose, your selection will provide you a balanced solution for all general documentation and image processing tasks.

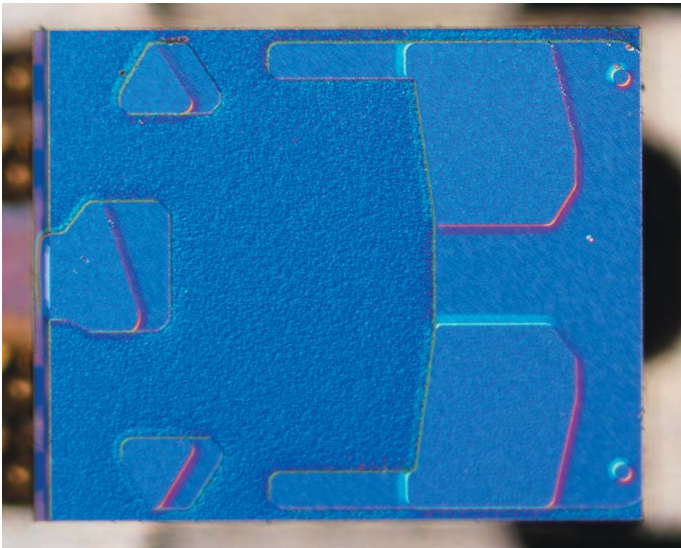

Ideal for standard applications like DIC image acquisition

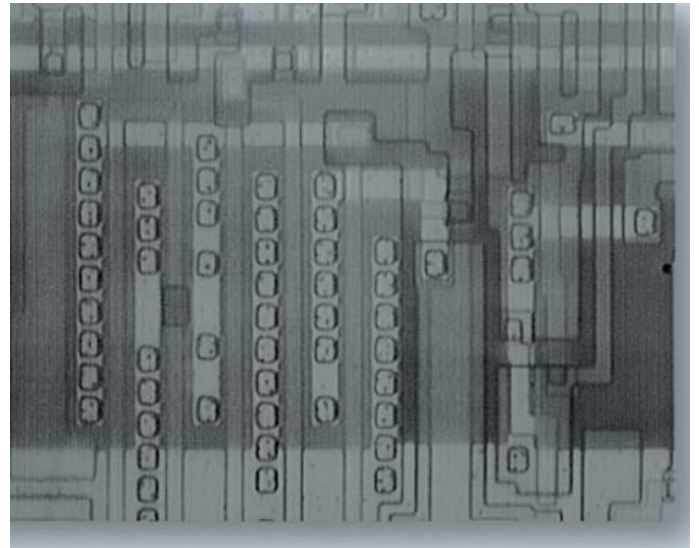

Infrared image acquired with the XM10-IR camera

Introductory Models

The specifications of sensors used in the introductory models make them excellent for standard bright field applications and superb for simple digital documentation purposes. In conjunction with its excellent cost/performance ratio, these are the perfect entry-level cameras for digital image acquisition in microscopes.

Gray Scale Models

XM10-IR is a highly sensitive monochrome camera incorporating a cooled 1.4 Mega-Pixel CCD. The camera provides a spectral sensitivity from the visible to 1050nm and is ideal for thin, through-silicon near IR imaging. With a 14-bit ADC, these cameras are used when gray scale values are of utmost importance.



Stand-alone camera — DP22/DP27 configuration example

Stand-Alone Models

DP22 and DP27 cameras can be used as a complete stand-alone model (no PC required). It is an ideal selection when precious bench space is limited. The camera is controlled from a dedicated control box providing smooth and intuitive operation via a touchscreen monitor or a mouse.

Olympus Digital Cameras Five Senses

A Camera for Various Applications.

Olympus offers a wide range of digital cameras for acquiring images of the highest quality that can be rated by resolution, contrast and perfect color reproduction. Some models are optimized for a dedicated application, like XC10 that provides frame rate and special electronic setup to transfer images while processing them. Other cameras like the DP73 or SC100 offer flexibility to deal with different applications, materials, sizes or shapes. The general camera control of OLYMPUS Stream guarantees intuitive operation for whatever camera you choose.

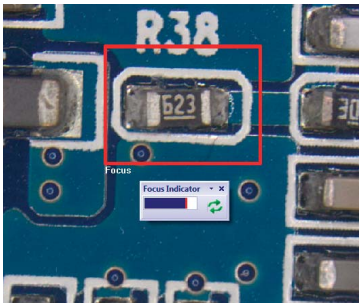

Live Inspection and Movie Recording

Even though camera speed is important when dealing with inspection tasks and online recording, image quality is also important. The best choice would be a camera that offers a high frame rate at full resolution. For a standalone set up, the DP22 is the perfect choice for live inspection.

Olympus Recommendation

- XC10
- SC30
- DP22
- XM10

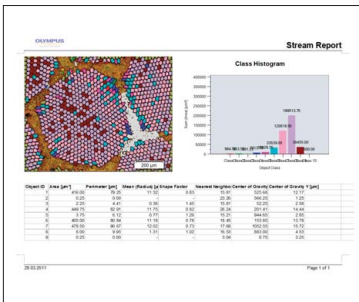

Documentation

Documentation is a well established task in industry and materials science. A camera mainly used for reporting should at least offer 5 Megapixels and excellent color reproduction. When you need detail zooming in your reports, a camera with more than 5 Megapixel is recommended for best results.

Olympus Recommendation

- DP73
- SC100
- DP27
- UC50



Measurements

Interactive measurements are standard tasks in materials science. For straightforward measurements 3 Megapixel cameras are sufficient. However, if accurate measurements are required, your camera should offer at least 5 Megapixels. This allows you to zoom in on the image and set the start and end point more precisely.

Olympus Recommendation

- DP73
- DP27
- UC50
- UC30

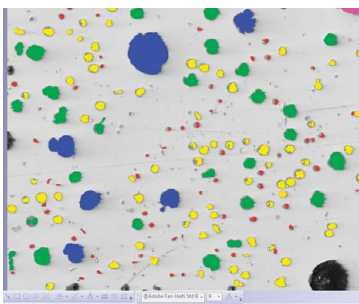
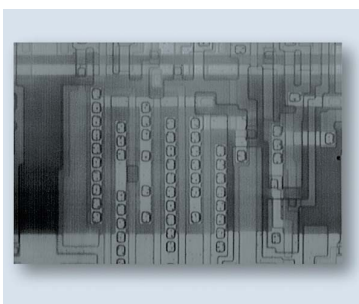

Image Analysis

Color reproduction is the main concern when you need to classify objects in color. Sensitivity is the other concern when dealing with image processing. Sensitivity can be increased by cooling and binning. Cooled models offer the advantage of images shown at full resolution while image resolution is reduced using binning.

Olympus Recommendation

- DP73
- XC50
- XC10



Difficult Imaging Conditions

Imaging under dark light conditions like fluorescence requires a very sensitive sensor. A monochrome one is the best choice for this application. For infrared image acquisition a monochrome sensor can be equipped with a special filter to provide a spectral response that is ideal for thin, through-silicon near IR imaging.

Olympus Recommendation

- XM10
- XM10IR

Keep Workflow Streamlined

OLYMPUS Stream Software Adapts to User's Requirement

The OLYMPUS Stream image analysis software allows users to seamlessly acquire images, process and measure them, and create a flexible database. OLYMPUS Stream provides the flexibility to fit your product to meet your needs without changing your operation. Time is just as important as working conditions, and OLYMPUS Stream system can be personalized to fit your process flow. An easy-to-use interface effortlessly guides the user through every step from image adjustment and capture to measurements, report and archiving — or whatever else you need to achieve. As a result, you'll find tasks are completed more efficiently, regardless of their complexity.

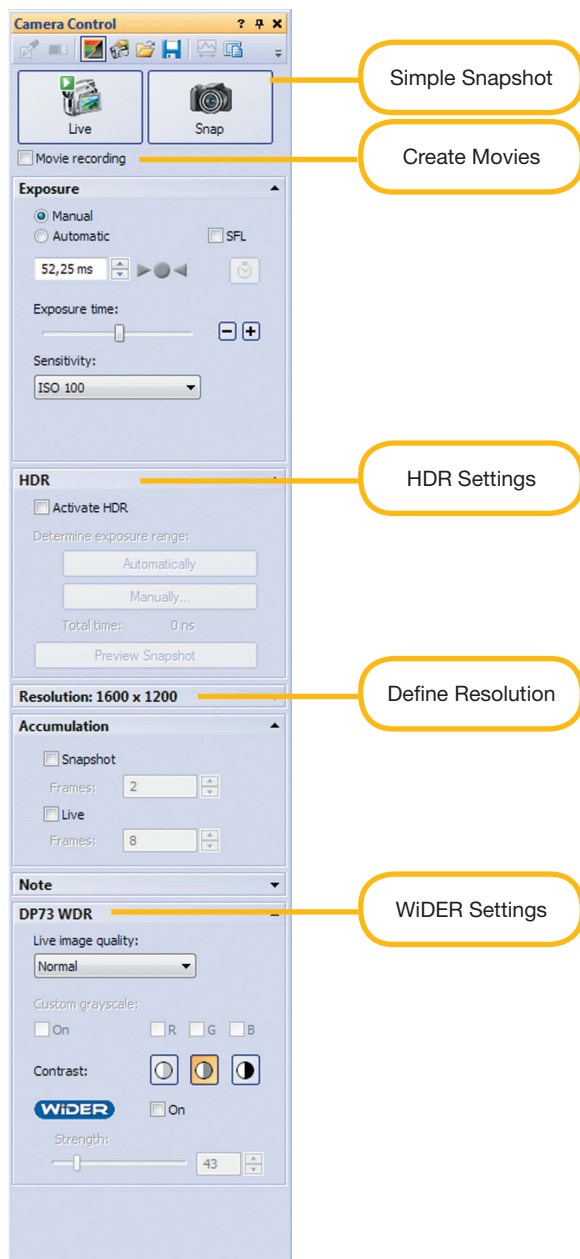

OLYMPUS Stream user interface for image acquisition

Full Integration

All Olympus digital cameras are perfectly integrated into OLYMPUS Stream. The camera control tool window groups all necessary functions in a compact overview: observe, adjust and snap.

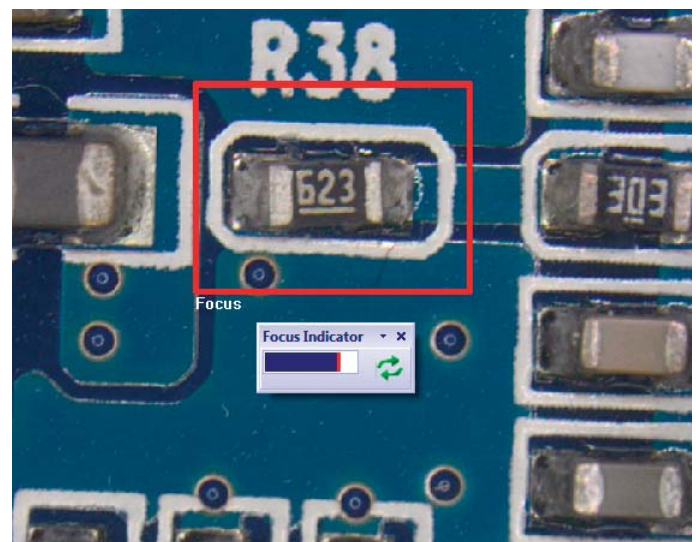

Focused live image

Live Zoom and Focus

The OLYMPUS Stream focus indicator enables the user to select a region of interest and bring it into optimum focus using the focus control of the microscope.

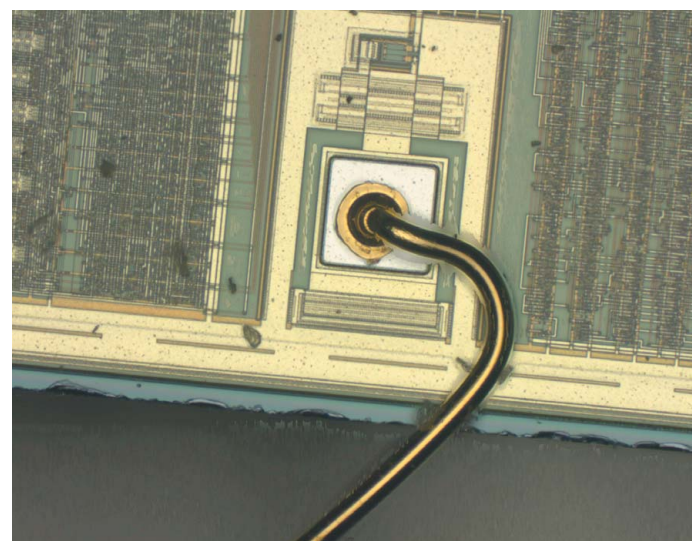

Perfectly focused images

Image with Extended Focus

The instant extended focus image (EFI) allows the use of the fine focus adjustment to combine many images in the Z-axis and to provide a single combined output that can be used for visualization or measuring in X and Y.

Microscope Digital Camera Specifications

Specifications	Universal model		Standard model				Introductory model		Stand-alone model*1	B/W model	
Category	Outstanding performance	First-rate flexibility	Best lateral resolution	Excellent sensitivity	Exceptional color fidelity	Impressive image quality	For standard applications	Cost performance	Space-saving	Monochrome Imaging	For IR observation
Digital camera	DP73	XC10	SC100	XC50	DP27	UC50	UC30	SC30	DP22	XM10	XM10IR
Resolution (megapixels)	17.3	1.4	10.6	5.0	5.0	5.0	3.2	3.3	2.8	1.4	1.4
Chip size (inches)	1/1.8 in. Color CCD	2/3 in. Color CCD	1/2.3 in. Color CMOS	2/3 in. Color CCD	2/3 in. Color CCD	2/3 in. Color CCD	1/1.8 in. Color CCD	1/2 in. Color CMOS	1/1.8 in. Color CCD	2/3 in. Monochrome CCD	2/3 in. Monochrome CCD
Pixel size (µm)	4.4 x 4.4	6.45 x 6.45	1.67 x 1.67	3.4 x 3.4	3.45 x 3.45	3.4 x 3.4	3.45 x 3.45	3.2 x 3.2	3.69 x 3.69	6.45 x 6.45	6.45 x 6.45
Exposure times	23 µs—60 s	100 µs—160 s	340 µs—14.6 s	100 µs—160 s	50 µs—8 s	100 µs—10 s	100 µs—10 s	61 µs—1.75 s	50 µs—8 s	100 µs—160 s	100 µs—160 s
ADC*2	14-bit	14-bit	12-bit	14-bit	12-bit	14-bit	14-bit	10-bit	12-bit	14-bit	14-bit
Live frame rates	27~15	50~15	45~3.2	24.5~5	30~15	24.5~4.5	35~7	49~10	30~25	80~15	80~15
Dimensions (mm, Ø x H)	85.4 (Ø) x 77.6 (H)	86 (Ø) x 48 (H)	58 (Ø) x 33 (H)	86 (Ø) x 48 (H)	77 (Ø) x 42.5 (H)	86 (Ø) x 48 (H)	86 (Ø) x 48 (H)	58 (Ø) x 33 (H)	77 (Ø) x 42.5 (H)	86 (Ø) x 48 (H)	86 (Ø) x 48 (H)
Weight (g, approx)	900	420	188	420	160	350	350	188	160	420	420
3 CCD mode	Available	-	-	-	-	-	-	-	-	-	-
WIDER mode	Option	-	-	-	-	-	-	-	-	-	-
Camera adapter	C-mount										
Control box	-	-	-	-	DP2-SAL	-	-	-	DP2-SAL	-	-
PC interface	PCI-Express x1 rev 1.0a or later	IEEE 1394a	USB 2.0	IEEE 1394a	USB 3.0	IEEE 1394a	IEEE 1394a	USB 2.0	IUSB3.0	IEEE 1394a	IEEE 1394a
OS	Windows 7/8 (64-bit)	Windows 8.1 (32-bit/64-bit) Pro Windows 8 (32-bit/64-bit) Pro Microsoft Windows 7 (32-bit/64-bit) Ultimate Microsoft Windows 7 (32-bit/64-bit) Professional									

*1 DP27 is also possible to use as a stand-alone model. *2 Analogue-to-digital converter. Actual bit depth of the camera depends on software used.

PC Requirements

CPU	Intel Core 2Duo or more (Intel Core i5, i7 recommended)
RAM	3 GB or more (8 GB recommended)
Hard disk	2.4 GB or more free space
Graphic card	1,280x1,024 monitor resolution with 32-bit video card

- OLYMPUS CORPORATION is ISO9001/ISO14001 certified.
- All company and product names are registered trademarks and/or trademarks of their respective owners.
- Images on the PC monitors are simulated.
- Specifications and appearances are subject to change without any notice or obligation on the part of the manufacturer.

www.olympus-ims.com

OLYMPUS[®]

OLYMPUS CORPORATION
Shinjuku Monolith, 2-3-1, Nishi-Shinjuku, Shinjuku-ku, Tokyo 163-0914, Japan
OLYMPUS EUROPA SE & CO. KG
Wendenstrasse 14-18, 20097 Hamburg, Germany

For enquiries - contact

www.olympus-ims.com/contact-us